









Wall Angle End Cabinet Assembly Instruction

(Item:WEC1242)

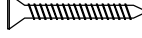
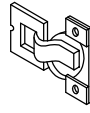
Hardware list	1 6pcs $\varnothing 4 \times 16\text{mm}$ Flat head screw	2 3pcs $\varnothing 4 \times 19\text{mm}$ Round head screw	3 8pcs $\varnothing 3.5 \times 14\text{mm}$ Color galvanized screw with flat head	4 8pcs $\varnothing 3.5 \times 16\text{mm}$ Color galvanized screw with flat head	5 12pcs $\varnothing 3.5 \times 35\text{mm}$ Black screw with flat head	6 3pcs 1-1/4" Hinge	7 12pcs 6mm Shelf clips						
													
Assembly tools required	Screw driver	Rubber mallet			10 2pcs 40mmx40mm Bracket rainbow 90°	9 2pcs $\varnothing 7$ Bumper	8 2set L-shape bracket						
													
Cabinet Part List	A	Front frame	B	Top&Bottom panel	C	Small side panel(1)	D	Big side panel(1)	E	Adjustable shelf(3)	F	Door	G

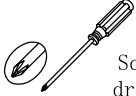
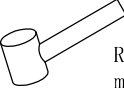
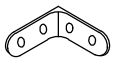
Step 1 : With front frame (A) of cabinet lay down on clean and soft surface then put glue into groove.

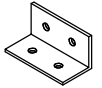
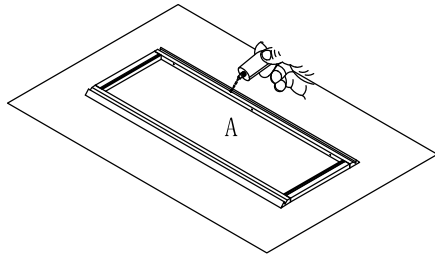

Step 2 : Install top&bottom panel. Insert into groove of front frame (A).

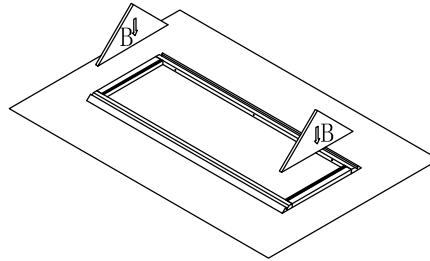

Step 3 : Install small side panel. Insert small side panel (C) into groove of front frame (A) until it into the groove of front frame (A).

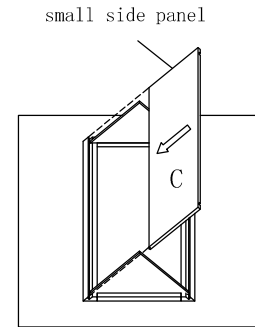

Step 4 : Install big side panel. Insert big side panel (D) into groove of front frame (A).

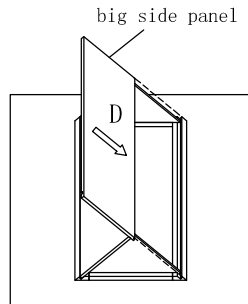

Step 5 : Install rainbow bracket. Screw the rainbow bracket to side panels and also screw the L-shape bracket to the front frame(A) and top panel(B), the same as the other hand .

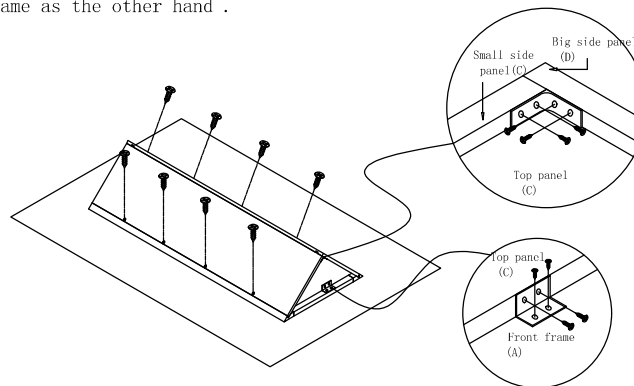

Step 6 : Install shelf clips and rainbow bracket. Insert shelf clips into the side panels and screw the rainbow bracket to the side panels and screw the L-shape bracket to the front frame(A) and top panel(B), the same as the other hand.

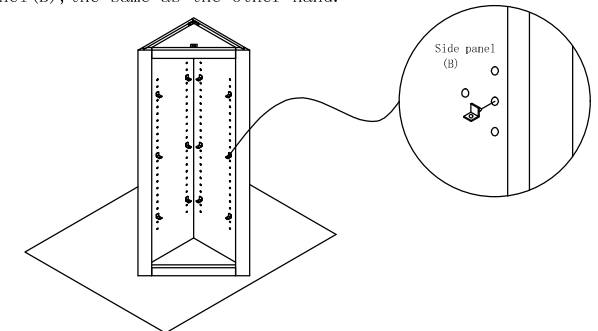

Wall Angle End Cabinet Assembly Instruction (Item:WEC1242)

Step 7 : Install adjustable shelf(F).Put the adjustable shelf on the shelf clips.

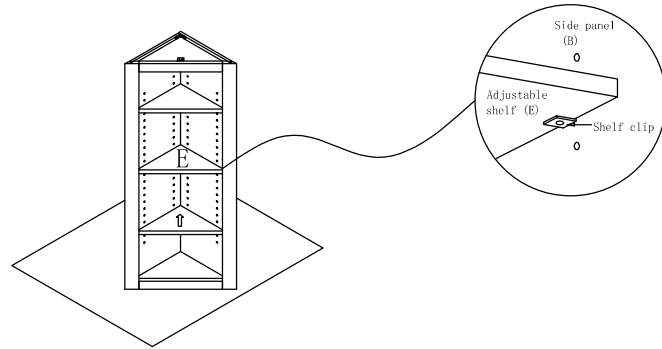

Step 8 : Install door(F). Screw the hinge to the door (F) and front frame (A).

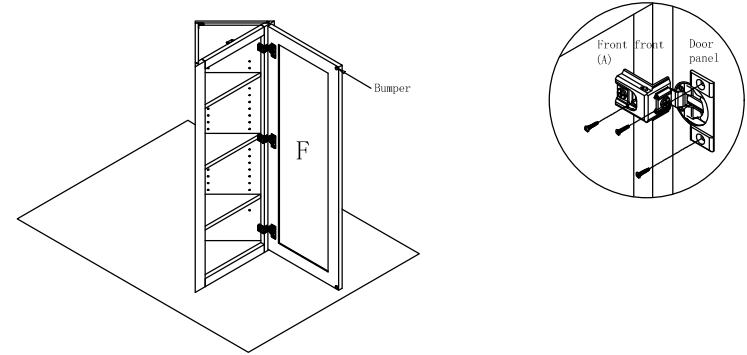

Step 9 : Finish installation of cabinet.

