









Wall Angle End Cabinet Assembly Instruction

(Item:WEC1230-WEC1236)

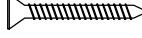
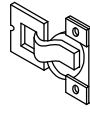
Hardware list	1 4pcs $\varnothing 4 \times 16 \text{mm}$ Flat head screw	2 2pcs $\varnothing 4 \times 19 \text{mm}$ Round head screw	3 8pcs $\varnothing 3.5 \times 14 \text{mm}$ Color galvanized screw with flat head	4 8pcs $\varnothing 3.5 \times 16 \text{mm}$ Color galvanized screw with flat head	5 12pcs $\varnothing 3.5 \times 35 \text{mm}$ Black screw with flat head	6 2pcs 1-1/4" Hinge	7 8pcs 6mm Shelf clips
							
Assembly tools required	Screw driver	Rubber mallet			10 2pcs 40mmx40mm Bracket rainbow 90°	9 2pcs $\varnothing 7$ Bumper	8 2set L-shape bracket
							
Cabinet Part List	A Front frame	B Top&Bottom panel	C Small side panel(1)	D Big side panel(1)	E Adjustable shelf(2)	F Door	G

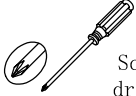
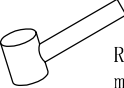
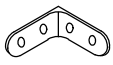
Step 1 : With front frame (A) of cabinet lay down on clean and soft surface then put glue into groove.

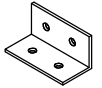
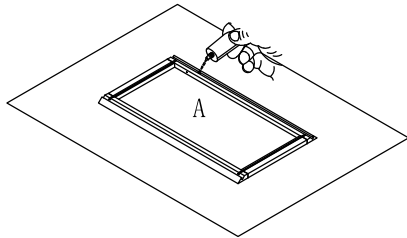

Step 2 : Install top&bottom panel. Insert into groove of front frame (A).

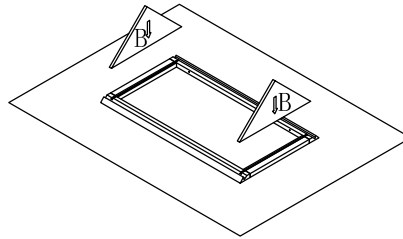

Step 3 : Install small side panel. Insert small side panel (C) into groove of front frame (A) until it into the groove of front frame (A).

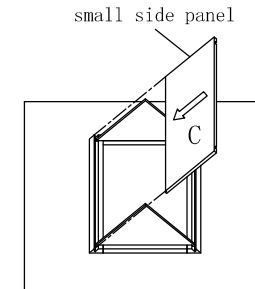

Step 4 : Install big side panel. Insert big side panel (D) into groove of front frame (A).

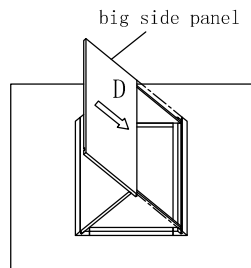

Step 5 : Install rainbow bracket. Screw the rainbow bracket to side panels and also screw the L-shape bracket to the front frame(A) and top panel(B), the same as the other hand .

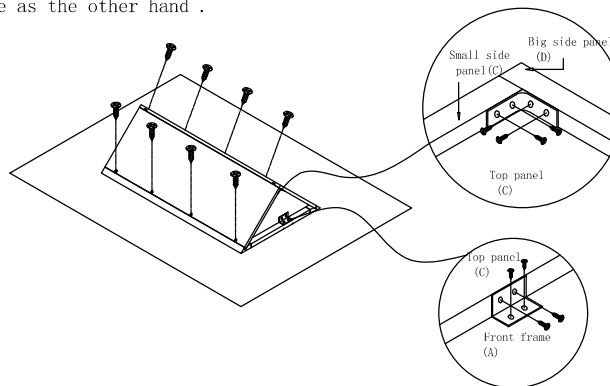

Step 6 : Install shelf clips and rainbow bracket. Insert shelf clips into the side panels and screw the rainbow bracket to the side panels and screw the L-shape bracket to the front frame(A) and top panel(B), the same as the other hand.

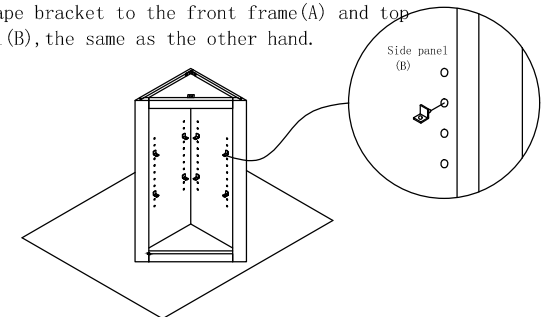

Wall Angle End Cabinet Assembly Instruction

(Item:WEC1230-WEC1236)

Step 7 : Install adjustable shelf(F).Put the adjustable shelf on the shelf clips.

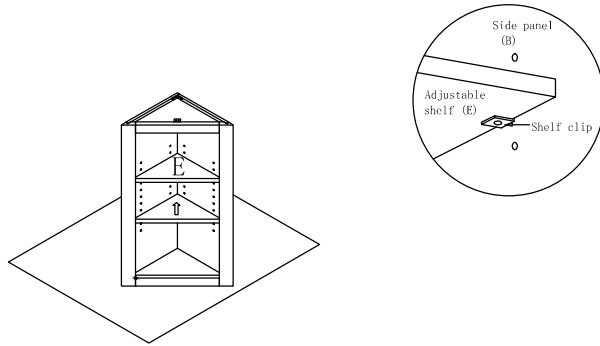

Step 8 : Install door(F). Screw the hinge to the door (F) and front frame (A).

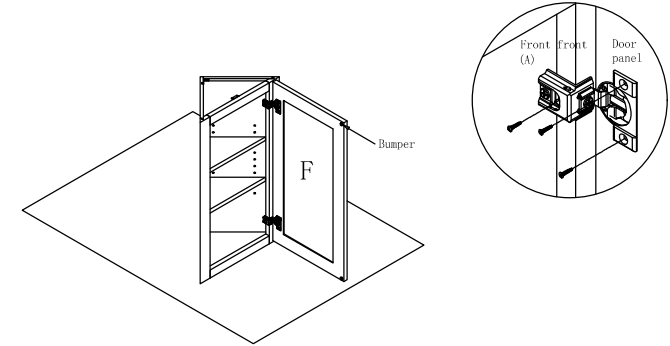

Step 9 : Finish installation of cabinet.

